

CR 2 English 18th
Century

$\frac{3}{4} \times \frac{35}{16}$
 $1\frac{3}{4}$
 $\frac{27}{8}$

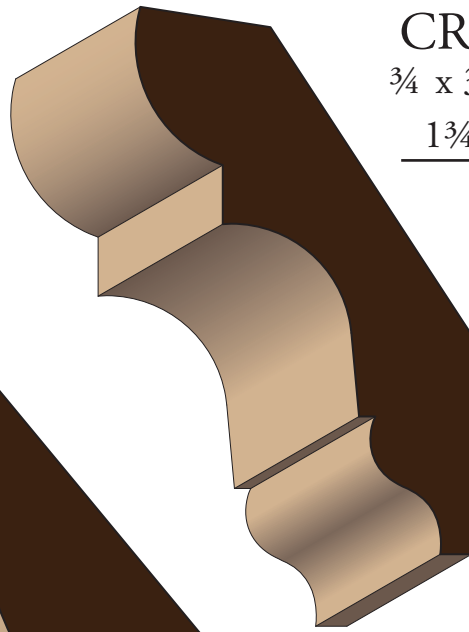

CR 241
 1 x $3\frac{3}{4}$
 American
 Late 19th
 Century

$1\frac{13}{16}$
 $\frac{35}{16}$

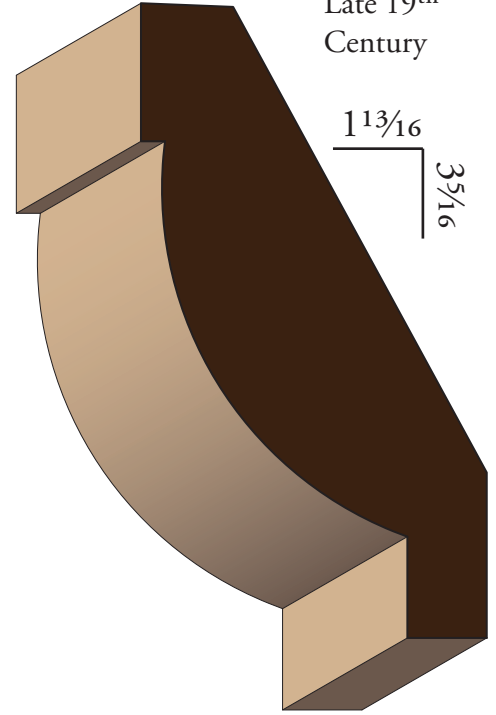

CR 343
 $\frac{13}{16} \times \frac{45}{8}$

$2\frac{15}{16}$
 $\frac{39}{16}$

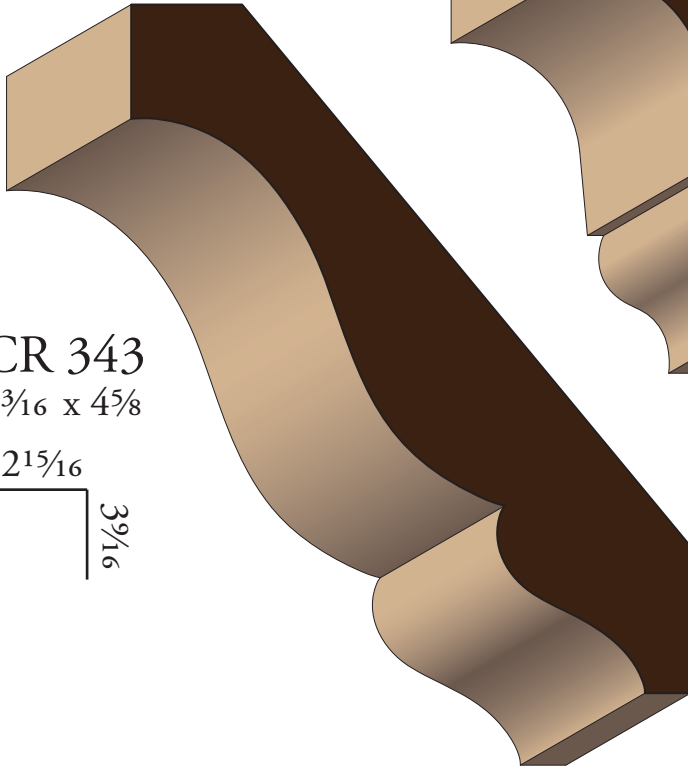

CR 280
 $\frac{15}{16} \times \frac{59}{16}$

$\frac{15}{16}$
 $\frac{59}{16}$

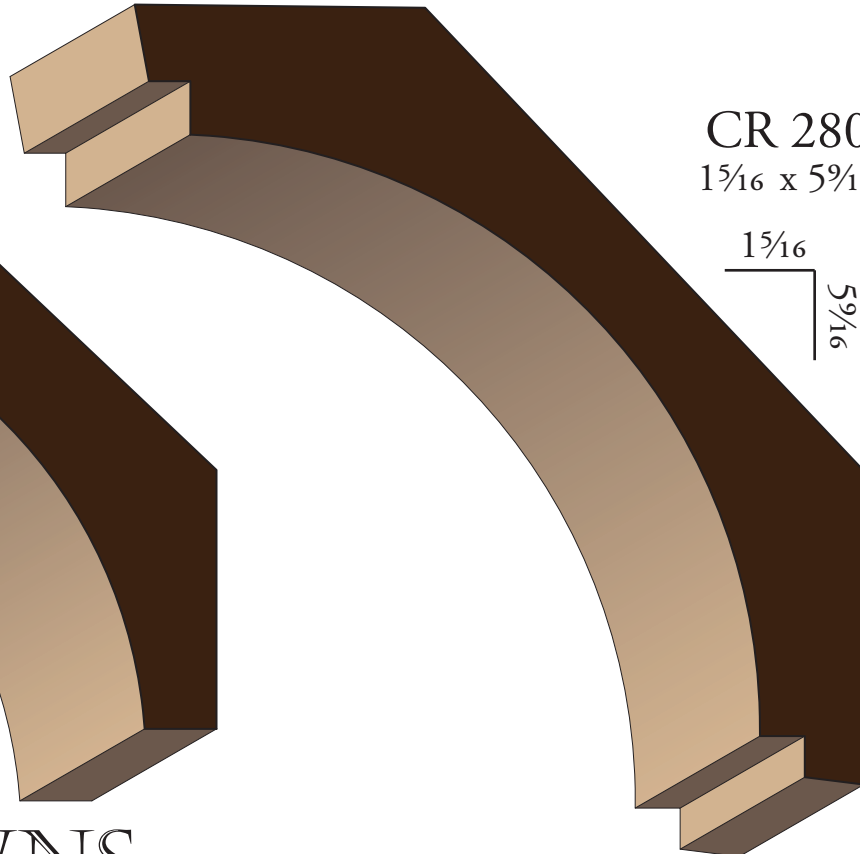

CR 159
 $\frac{13}{16} \times \frac{41}{8}$

$\frac{27}{8}$
 3

