

CR 5
 $\frac{3}{4} \times 4\frac{5}{16}$
 $\frac{3}{8}$
 $\frac{31}{16}$

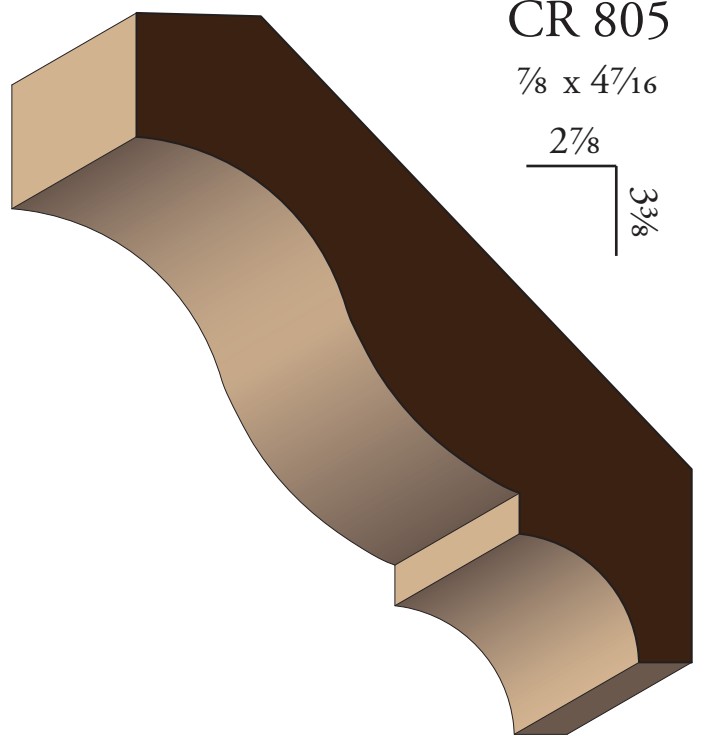

CR 805
 $\frac{7}{8} \times 4\frac{7}{16}$
 $\frac{2}{8}$
 $\frac{3}{8}$

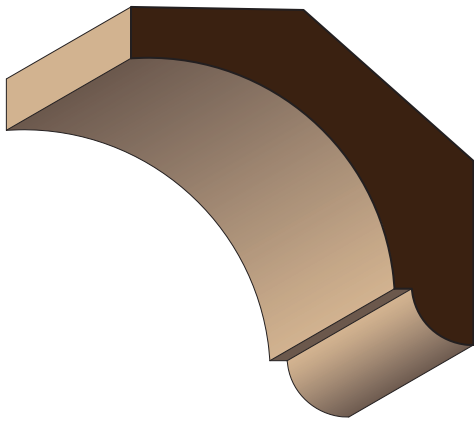

CR 618
 $\frac{3}{4} \times 2\frac{1}{2}$
 $1\frac{13}{16}$
 $\frac{1}{4}$

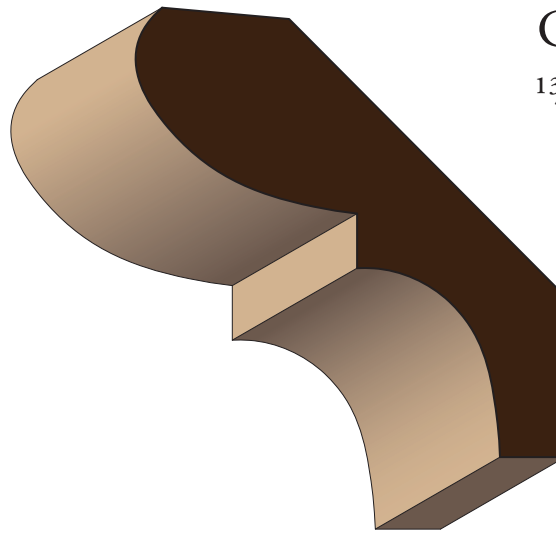

CR 785
 $1\frac{3}{16} \times 3\frac{3}{16}$
 $\frac{2}{4}$
 $\frac{25}{16}$

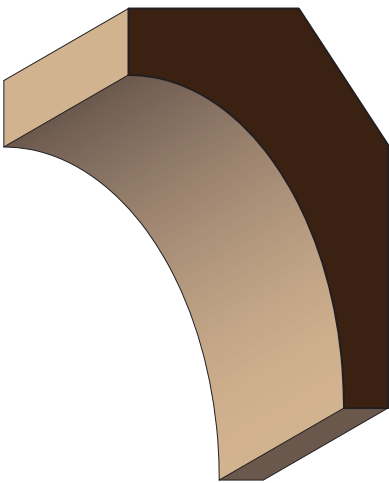

CR 418
 $1\frac{5}{16} \times 2\frac{1}{2}$
 $\frac{1}{8}$
 $\frac{21}{16}$

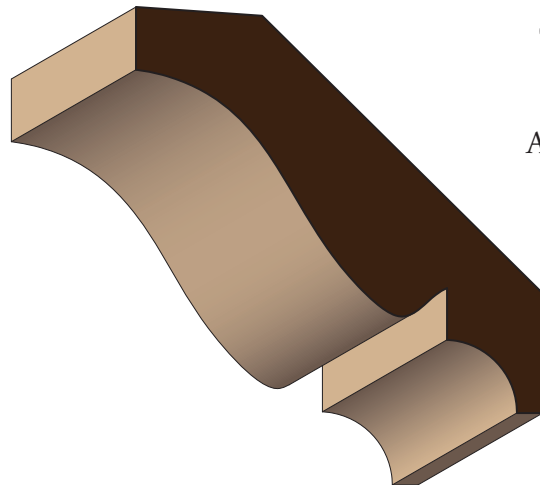

CR 342
 $1\frac{1}{16} \times 3$
American Mid-19th Century
 $\frac{2}{8}$
 $\frac{21}{8}$